

ALL DIMENSIONS IN MM (EXCEPT HTA AND STA IN °)

ALLE MASSE IN MM (AUSNAHME HTA UND STA IN °)

- STL** SEAT TUBE LENGTH
SITZROHRLÄNGE
- CSL** CHAINSTAY LENGTH
KETTENSTREBENLÄNGE
- TTL** TOP TUBE LENGTH
OBERROHRLÄNGE
- HTL** HEAD TUBE LENGTH
STEUERROHRLÄNGE
- HTA** HEAD TUBE ANGLE
STEUERROHRWINKEL
- STA** SEAT TUBE ANGLE
SITZROHRWINKEL
- BB** BOTTOM BRACKET DROP
INNENLAGERABSENKUNG
- WB** WHEELBASE
RADSTAND
- ST** STACK
STACK
- RE** REACH
REACH
- SOH** STANDOVER HEIGHT
ÜBERSTANDSHÖHE
- HEAD SET DIAMETER (UPPER / LOWER)
STEUERSATZDURCHMESSER (OBEN / UNTEN)
- AXLE STANDARD (REAR / FRONT)
ACHSENSTANDARD (HINTEN / VORNE)
- BOTTOM BRACKET STANDARD
TRETLAGERSTANDARD
- SEAT POST DIAMETER
SÄTTELSTÜTZENDURCHMESSER
- SHOCK HARDWARE (Ø 8 MM)
DÄMPFERBUCHSENMASSE (Ø 8 MM)
- SHOCK LENGTH
DÄMPFEREINBAULÄNGE
- SHOCK TRAVEL
DÄMPFERHUB
- FRONT FORK TRAVEL
FEDERWEG VORNE
- REAR WHEEL TRAVEL
FEDERWEG HINTEN
- STEM LENGTH
VORBAULÄNGE
- HANDLEBAR WIDTH
LENKERBREITE
- CRANK LENGTH
KURBELLÄNGE
- SEAT TUBE BOTTLE MOUNT
FLASCHE SÄTTELROHR
- DOWNTUBE BOTTLE MOUNT
FLASCHE UNTERROHR

STL CSL TTL HTL HTA STA BB WB ST RE SOH ST DT

PATH RIOT LTD	STL	CSL	TTL	HTL	HTA	STA	BB	WB	ST	RE	SOH														
S	417	446	580	90	64	77	38.1	1219	604	440	742	0 / 0	148/110	34,9	Trunnion / 30x10	185	55	150	140	40	760	170	-	0,5	
M	441	446	614	110	64	77	38.1	1257	622	470	757	0 / 0	148/110	34,9	Trunnion / 30x10	185	55	150	140	40	780	170	-	0,75	
L	465	455	646	140	64	77	33.2	1306	644	497	783	0 / 0	148/110	34,9	Trunnion / 30x10	185	55	150	140	40	780	175	-	0,75	
XL	489	455	680	160	64	77	33.2	1345	662	527	801	0 / 0	148/110	34,9	Trunnion / 30x10	185	55	150	140	40	780	175	-	0,75	

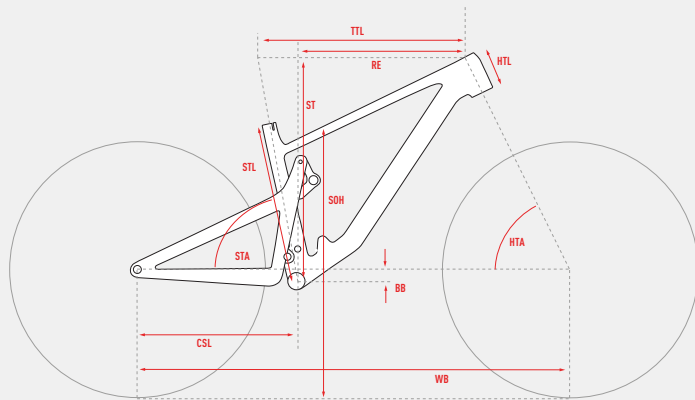

ALL DIMENSIONS IN MM (EXCEPT HTA AND STA IN °)

ALLE MASSE IN MM (AUSNAHME HTA UND STA IN °)

- STL** SEAT TUBE LENGTH
SITZROHRLÄNGE
- CSL** CHAINSTAY LENGTH
KETTENSTREBENLÄNGE
- TTL** TOP TUBE LENGTH
OBERROHRLÄNGE
- HTL** HEAD TUBE LENGTH
STEUERROHRLÄNGE
- HTA** HEAD TUBE ANGLE
STEUERROHRWINKEL
- STA** SEAT TUBE ANGLE
SITZROHRWINKEL
- BB** BOTTOM BRACKET DROP
INNENLAGERABSENKUNG
- WB** WHEELBASE
RADSTAND
- ST** STACK
STACK
- RE** REACH
REACH
- SOH** STANDOVER HEIGHT
ÜBERSTANDSHÖHE
- HEAD SET DIAMETER (UPPER / LOWER)
STEUERSATZDURCHMESSER (OBEN / UNTEN)
- AXLE STANDARD (REAR / FRONT)
ACHSENSTANDARD (HINTEN / VORNE)
- BOTTOM BRACKET STANDARD
TRETLAGERSTANDARD
- SEAT POST DIAMETER
SÄTTELSTÜTZENDURCHMESSER
- SHOCK HARDWARE (Ø 8 MM)
DÄMPFERBUCHSENMASSE (Ø 8 MM)
- SHOCK LENGTH
DÄMPFERENBAULÄNGE
- SHOCK TRAVEL
DÄMPFERHUB
- FRONT FORK TRAVEL
FEDERWEG VORNE
- REAR WHEEL TRAVEL
FEDERWEG HINTEN
- STEM LENGTH
VORBAULÄNGE
- HANDLEBAR WIDTH
LENKERBREITE
- CRANK LENGTH
KURBELLENLÄNGE
- SEAT TUBE BOTTLE MOUNT
FLASCHE SÄTTELROHR
- DOWNTUBE BOTTLE MOUNT
FLASCHE UNTERROHR

STL CSL TTL HTL HTA STA BB WB ST RE SOH ST DT

PATH RIOT ADVANCED

	STL	CSL	TTL	HTL	HTA	STA	BB	WB	ST	RE	SOH														ST		DT
S	417	446	581	90	63.5	76.5	34.2	1224	607	435	746	0 / 0	148/110	34,9	Trunnion / 30x10	185	55	160	140	45	760	170	-	0,5			
M	441	446	615	110	63.5	76.5	34.3	1263	626	465	762	0 / 0	148/110	34,9	Trunnion / 30x10	185	55	160	140	45	780	170	-	0,75			
L	465	455	647	140	63.5	76.5	29.5	1312	648	492	787	0 / 0	148/110	34,9	Trunnion / 30x10	185	55	160	140	45	780	175	-	0,75			
XL	489	455	681	160	63.5	76.5	29.6	1350	666	522	805	0 / 0	148/110	34,9	Trunnion / 30x10	185	55	160	140	45	780	175	-	0,75			

STL CSL TTL HTL HTA STA BB WB ST RE SOH ST DT

PATH RIOT FULL PARTY



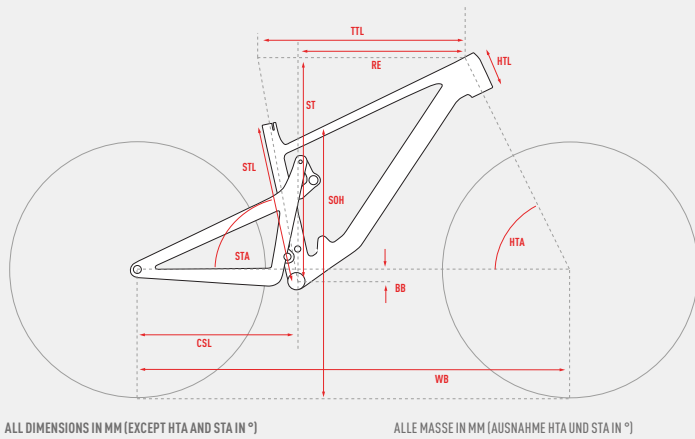











	STL	CSL	TTL	HTL	HTA	STA	BB	WB	ST	RE	SOH														ST		DT
S	417	446	581	90	63.5	76.5	34.2	1224	607	435	746	0 / 0	148/110	34,9	Trunnion / 30x10	185	55	160	140	45	760	170	-	0,5			
M	441	446	615	110	63.5	76.5	34.3	1263	626	465	762	0 / 0	148/110	34,9	Trunnion / 30x10	185	55	160	140	45	780	170	-	0,75			
L	465	455	647	140	63.5	76.5	29.5	1312	648	492	787	0 / 0	148/110	34,9	Trunnion / 30x10	185	55	160	140	45	780	175	-	0,75			
XL	489	455	681	160	63.5	76.5	29.6	1350	666	522	805	0 / 0	148/110	34,9	Trunnion / 30x10	185	55	160	140	45	780	175	-	0,75			



ALL DIMENSIONS IN MM (EXCEPT HTA AND STA IN °)















ALLE MASSE IN MM (AUSNAHME HTA UND STA IN °)

- STL** SEAT TUBE LENGTH
SITZROHRLÄNGE
- CSL** CHAINSTAY LENGTH
KETTENSTREBENLÄNGE
- TTL** TOP TUBE LENGTH
OBERROHRLÄNGE
- HTL** HEAD TUBE LENGTH
STEUERROHRLÄNGE
- HTA** HEAD TUBE ANGLE
STEUERROHRWINKEL
- STA** SEAT TUBE ANGLE
SITZROHRWINKEL
- BB** BOTTOM BRACKET DROP
INNENLAGERABSENKUNG
- WB** WHEELBASE
RADSTAND
- ST** STACK
STACK
- RE** REACH
REACH
- SOH** STANDOVER HEIGHT
ÜBERSTANDSHÖHE
-  HEAD SET DIAMETER (UPPER / LOWER)
STEUERSATZDURCHMESSER (OBEN / UNTEN)
-  AXLE STANDARD (REAR / FRONT)
ACHSENSTANDARD (HINTEN / VORNE)
-  BOTTOM BRACKET STANDARD
TRETLAGERSTANDARD
-  SEAT POST DIAMETER
SÄTTELSTÜTZENDURCHMESSER
-  SHOCK HARDWARE (Ø 8 MM)
DÄMPFERBUCHSENMASSE (Ø 8 MM)
-  SHOCK LENGTH
DÄMPFEREINBAULÄNGE
-  SHOCK TRAVEL
DÄMPFERHUB
-  FRONT FORK TRAVEL
FEDERWEG VORNE
-  REAR WHEEL TRAVEL
FEDERWEG HINTEN
-  STEM LENGTH
VORBAULÄNGE
-  HANDLEBAR WIDTH
LENKERBREITE
-  CRANK LENGTH
KURBELLÄNGE
-  SEAT TUBE BOTTLE MOUNT
FLASCHE SÄTTELROHR
-  DOWNTUBE BOTTLE MOUNT
FLASCHE UNTERROHR

STL CSL TTL HTL HTA STA BB WB ST RE SOH              















RIOT AM FULL PARTY

	STL	CSL	TTL	HTL	HTA	STA	BB	WB	ST	RE	SOH														
S	417	446	581	90	63.5	76.5	34.2	1224	607	435	746	0 / 0	148/110	34,9	Trunnion / 30x10	185	55	160	140	45	760	170	-	0,5	
M	441	446	615	110	63.5	76.5	34.3	1263	626	465	753	0 / 0	148/110	34,9	Trunnion / 30x10	185	55	160	140	45	800	170	-	0,75	
L	465	455	647	140	63.5	76.5	29.5	1312	648	492	778	0 / 0	148/110	34,9	Trunnion / 30x10	185	55	160	140	45	800	175	-	0,75	
XL	489	455	681	160	63.5	76.5	29.6	1350	666	522	796	0 / 0	148/110	34,9	Trunnion / 30x10	185	55	160	140	45	800	175	-	0,75	

STL CSL TTL HTL HTA STA BB WB ST RE SOH              















RIOT AM PRO

	STL	CSL	TTL	HTL	HTA	STA	BB	WB	ST	RE	SOH														
S	417	446	581	90	63.5	76.5	34.2	1224	607	435	746	0 / 0	148/110	34,9	Trunnion / 30x10	185	55	160	140	45	760	170	-	0,5	
M	441	446	615	110	63.5	76.5	34.3	1263	626	465	753	0 / 0	148/110	34,9	Trunnion / 30x10	185	55	160	140	45	800	170	-	0,75	
L	465	455	647	140	63.5	76.5	29.5	1312	648	492	778	0 / 0	148/110	34,9	Trunnion / 30x10	185	55	160	140	45	800	175	-	0,75	
XL	489	455	681	160	63.5	76.5	29.6	1350	666	522	796	0 / 0	148/110	34,9	Trunnion / 30x10	185	55	160	140	45	800	175	-	0,75	

STL CSL TTL HTL HTA STA BB WB ST RE SOH              

RIOT TRAIL FULL PARTY

	STL	CSL	TTL	HTL	HTA	STA	BB	WB	ST	RE	SOH														
S	417	446	580	90	64	77	38.1	1219	604	441	742	0 / 0	148/110	34,9	Trunnion / 30x10	185	55	150	140	45	760	170	-	0,5	
M	441	446	614	110	64	77	38.1	1258	622	471	749	0 / 0	148/110	34,9	Trunnion / 30x10	185	55	150	140	45	800	170	-	0,75	
L	465	455	646	140	64	77	33.3	1307	644	497	775	0 / 0	148/110	34,9	Trunnion / 30x10	185	55	150	140	45	800	175	-	0,75	
XL	489	455	678	160	64	77	33.3	1346	662	527	793	0 / 0	148/110	34,9	Trunnion / 30x10	185	55	150	140	45	800	175	-	0,75	

STL CSL TTL HTL HTA STA BB WB ST RE SOH              

RIOT TRAIL PRO

	STL	CSL	TTL	HTL	HTA	STA	BB	WB	ST	RE	SOH														
S	417	446	580	90	64	77	38.1	1219	604	441	742	0 / 0	148/110	34,9	Trunnion / 30x10	185	55	150	140	45	760	170	-	0,5	
M	441	446	614	110	64	77	38.1	1258	622	471	749	0 / 0	148/110	34,9	Trunnion / 30x10	185	55	150	140	45	800	170	-	0,75	
L	465	455	646	140	64	77	33.3	1307	644	497	775	0 / 0	148/110	34,9	Trunnion / 30x10	185	55	150	140	45	800	175	-	0,75	
XL	489	455	679	160	64	77	33.3	1346	662	527	793	0 / 0	148/110	34,9	Trunnion / 30x10	185	55	150	140	45	800	175	-	0,75	

